

Maswell 7 in 1 5G 4x4 MIMO WiFi 2x2 MIMO and GNSS High-precision Combination Antenna

AN.4MIMO.700.5000.4C.2W.1GNSS

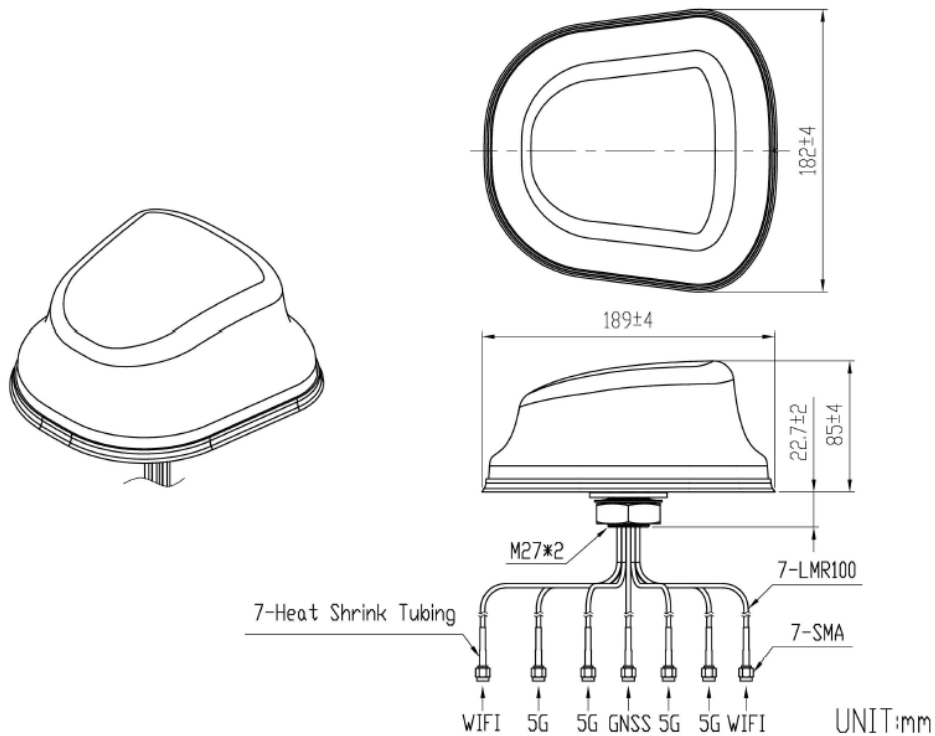

Mechanical dimension



Maswell 7 in 1 5G 4x4 MIMO WiFi 2x2 MIMO and GNSS High-precision Combination Antenna

AN.4MIMO.700.5000.4C.2W.1GNSS

Specifications

Item	Specifications	
Antenna 1: 5G	Frequency Range	698-960MHz/1710-2690MHz/2900-5000MHz
	Polarization	Linear
	Gain	4dBi (typically)
	V.S.W.R	<3
	Efficiency	>50%
Antenna 2: 5G	Frequency Range	698-960MHz/1710-2690MHz/2900-5000MHz
	Polarization	Linear
	Gain	4dBi (typically)
	V.S.W.R	<3
	Efficiency	>50%
Antenna 3: 5G	Frequency Range	698-960MHz/1710-2690MHz/2900-5000MHz
	Polarization	Linear
	Gain	4dBi (typically)
	V.S.W.R	<3
	Efficiency	>50%
Antenna 4: 5G	Frequency Range	698-960MHz/1710-2690MHz/2900-5000MHz
	Polarization	Linear
	Gain	4dBi (typically)
	V.S.W.R	<3
	Efficiency	>50%

Maswell 7 in 1 5G 4x4 MIMO WiFi 2x2 MIMO and GNSS High-precision Combination Antenna

AN.4MIMO.700.5000.4C.2W.1GNSS

Specifications

Item	Specifications	
Antenna 5: GNSS	Frequency Range	GPS L1 / L2 / L5 GLONASS G1/G2/G3 COMPASS B1 / B2 / B3 Galileo E1 / L1 / E2 / E5a / E5b / E6
	Polarization	RHCP
	Axial Ratio	≤3dB
	V.S.W.R	≤1.5
	Peak Gain	≥5.5dBi
	Impedance	50Ω
	Phase Center Offset	±2mm
	Horizontal Orientation	360°
Antenna 6 and Antenna 7: WiFi/V2X/Bluetooth	Frequency Range	2400~2483.5MHz/4900~5925 MHz
	V.S.W.R	<2.5
	Polarization	Linear
	Gain	4dBi (typically)
	Impedance	50Ω
Mechanical	Dimension	190mm *183mm*22.7mm
	Connector Type	GNSS/5G : SMA male WiFi: RP SMA plug
	Radome	PC/ABS
	Cable	LMR 100 2 meters
Environmental	Operating Temperature	-40°C~+85°C
	Relative Humidity	Up to 95%
	Vibration	10 to 55Hz with 1.5mm amplitude 2hours
	Ingress Protection	IP67(exclude cable outlet)
	Environmentally Friendly	ROHS Compliant

Maswell 7 in 1 5G 4x4 MIMO WiFi 2x2 MIMO and GNSS High-precision Combination Antenna

AN.4MIMO.700.5000.4C.2W.1GNSS

GPS Antenna Part Pattern

GNSS Antenna

XY-PLANE

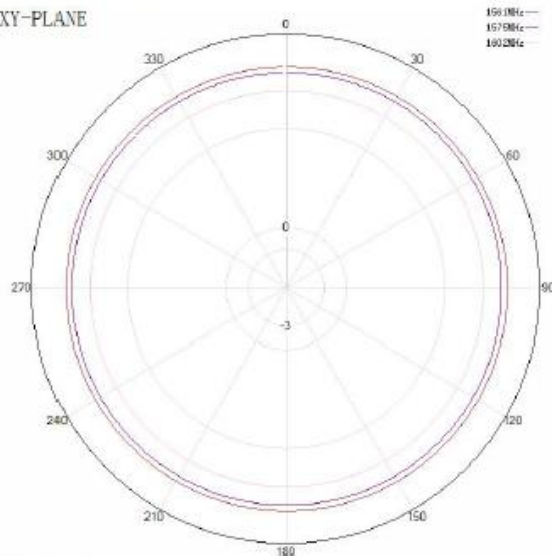

XZ-PLANE

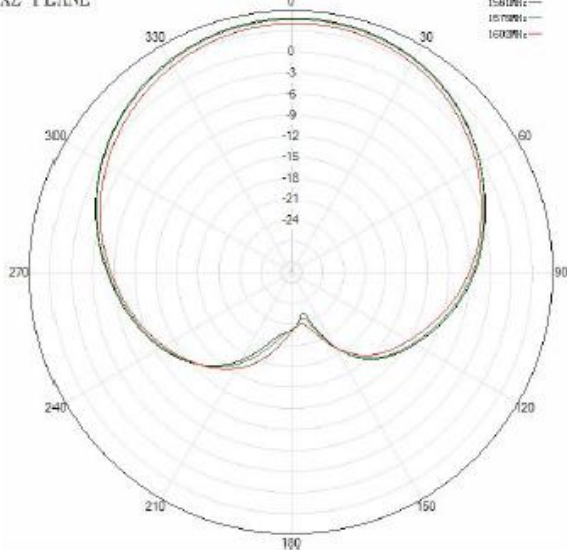

YZ-PLANE

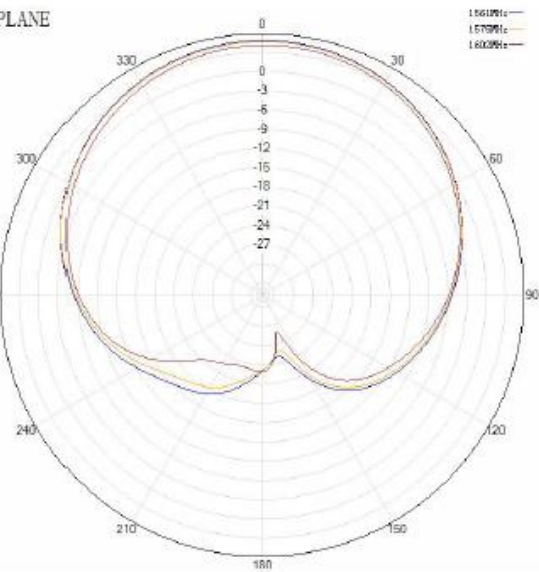

Maswell 7 in 1 5G 4x4 MIMO WiFi 2x2 MIMO and GNSS High-precision Combination Antenna

AN.4MIMO.700.5000.4C.2W.1GNSS

5G Antenna Part Pattern

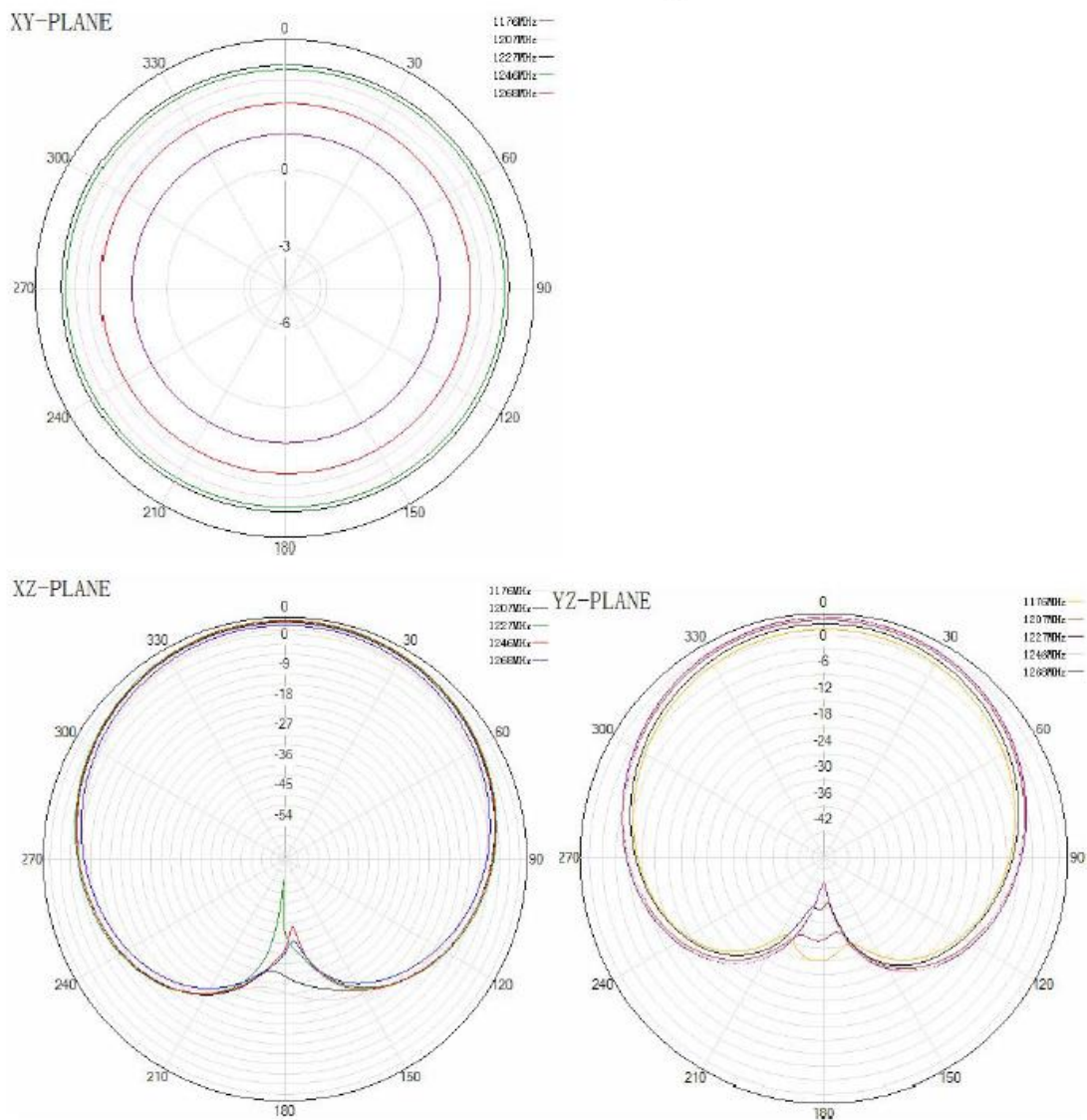

Maswell 7 in 1 5G 4x4 MIMO WiFi 2x2 MIMO and GNSS High-precision Combination Antenna

AN.4MIMO.700.5000.4C.2W.1GNSS

5G Antenna Part Pattern

NR Antenna

5G-1 XY PLANE

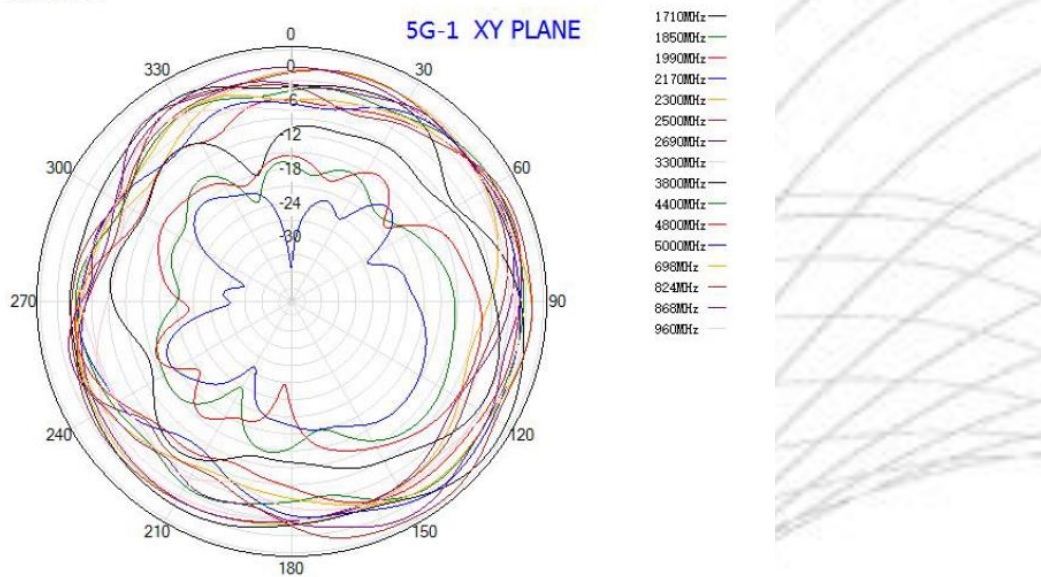

5G-1 XZ PLANE

5G-1 YZ PLANE

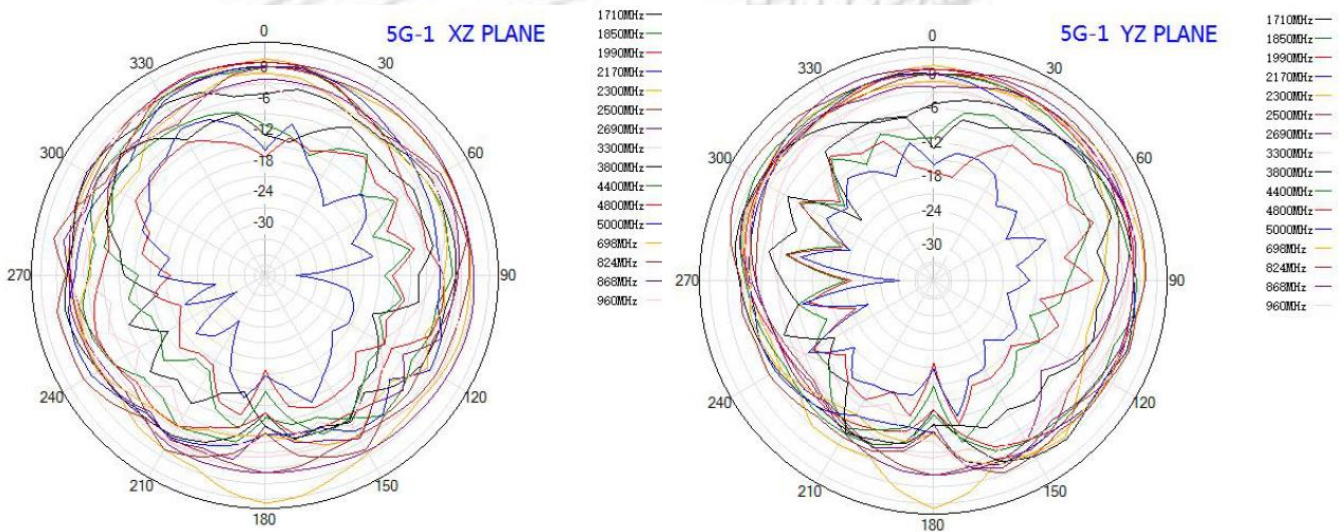

Maswell 7 in 1 5G 4x4 MIMO WiFi 2x2 MIMO and GNSS High-precision Combination Antenna

AN.4MIMO.700.5000.4C.2W.1GNSS

5G Antenna Part Pattern

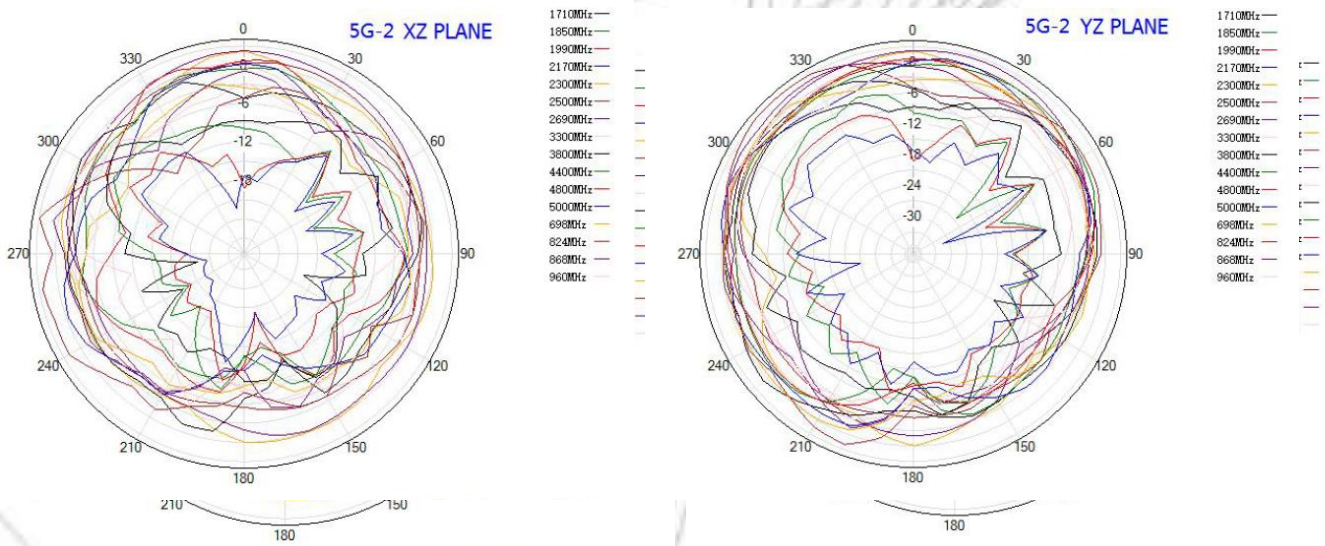
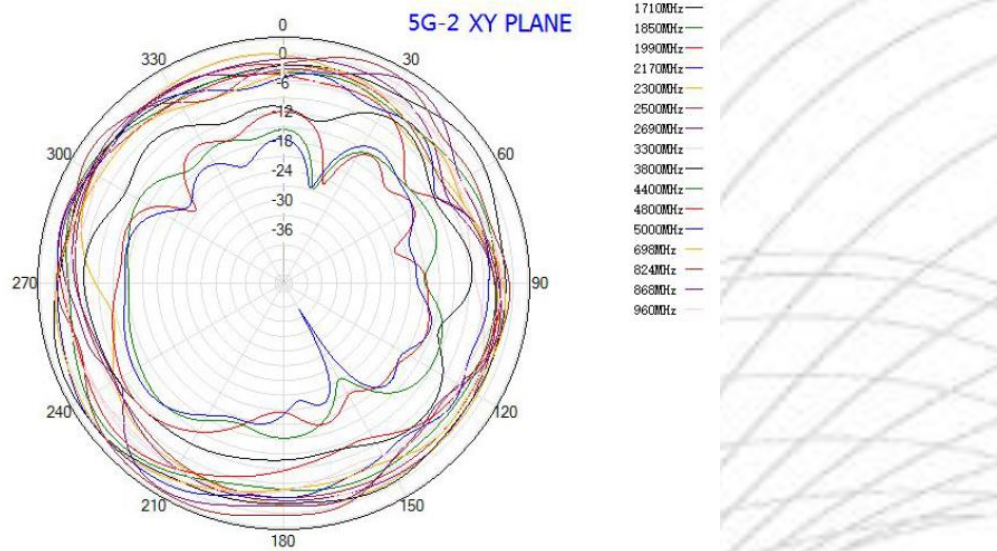

Maswell 7 in 1 5G 4x4 MIMO WiFi 2x2 MIMO and GNSS High-precision Combination Antenna

AN.4MIMO.700.5000.4C.2W.1GNSS

5G Antenna Part Pattern

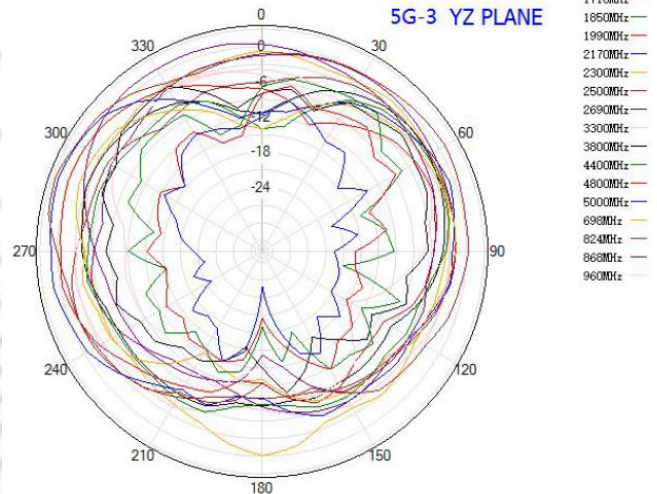
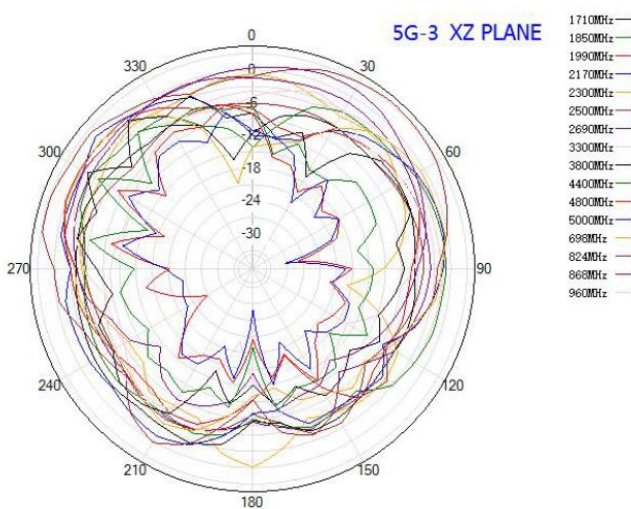
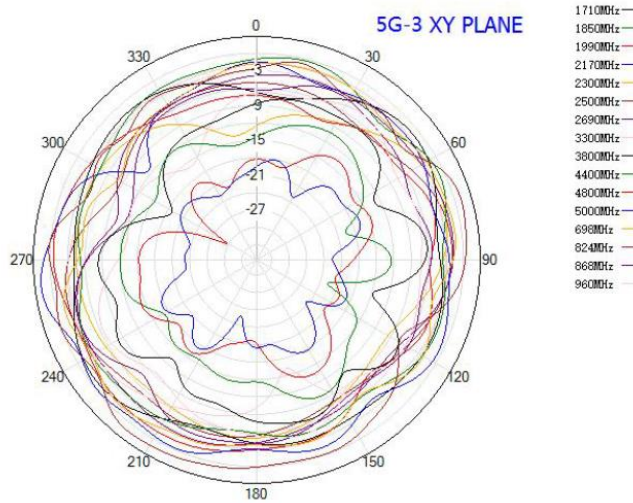

Maswell 7 in 1 5G 4x4 MIMO WiFi 2x2 MIMO and GNSS High-precision Combination Antenna

AN.4MIMO.700.5000.4C.2W.1GNSS

5G Antenna Part Pattern

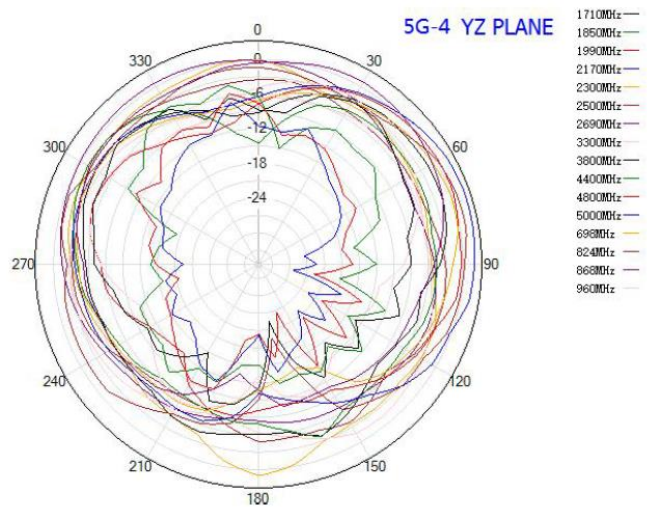
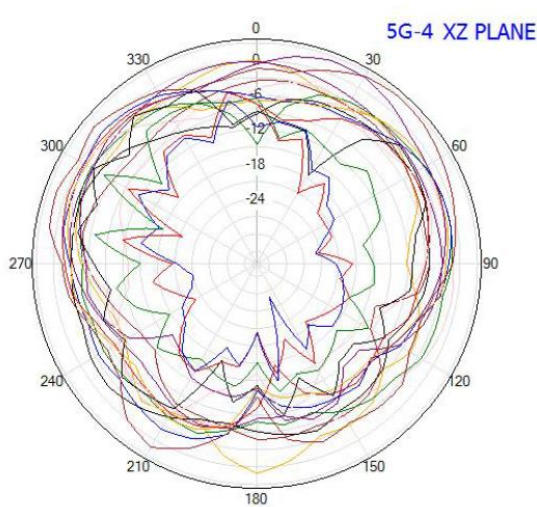
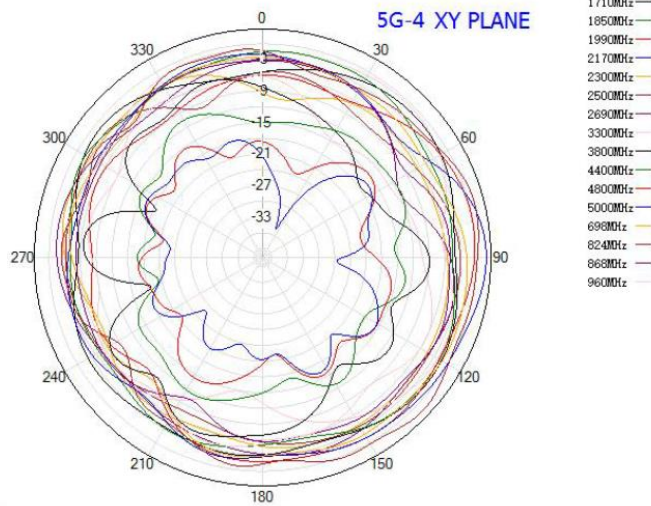

Maswell 7 in 1 5G 4x4 MIMO WiFi 2x2 MIMO and GNSS High-precision Combination Antenna

AN.4MIMO.700.5000.4C.2W.1GNSS

WiFi Antenna Part Pattern

WiFi Antenna

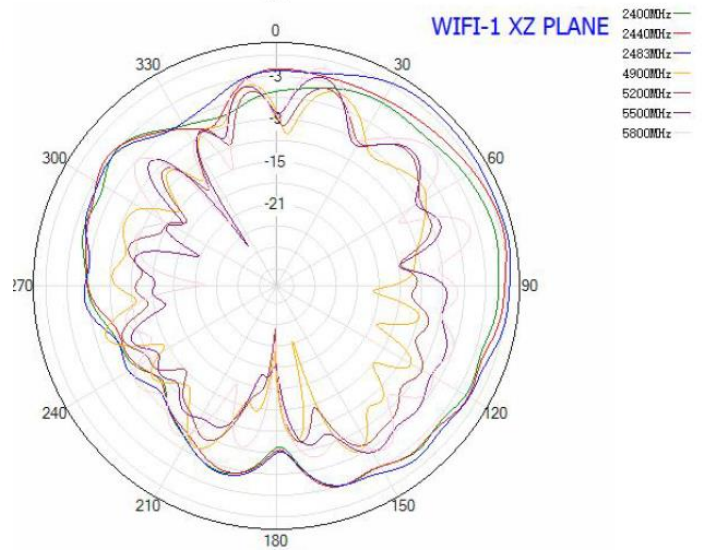
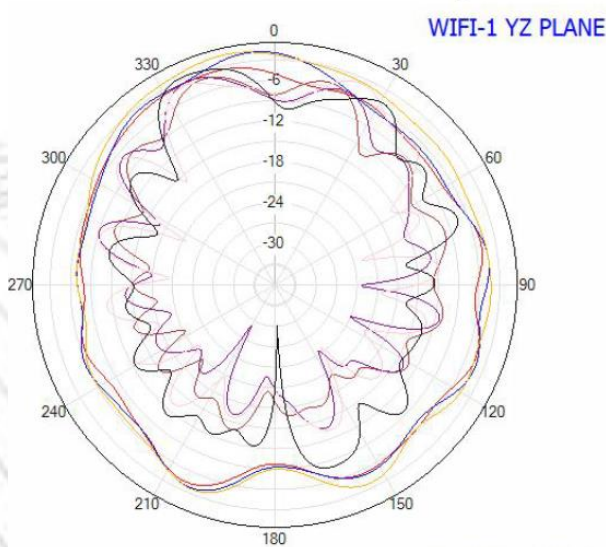
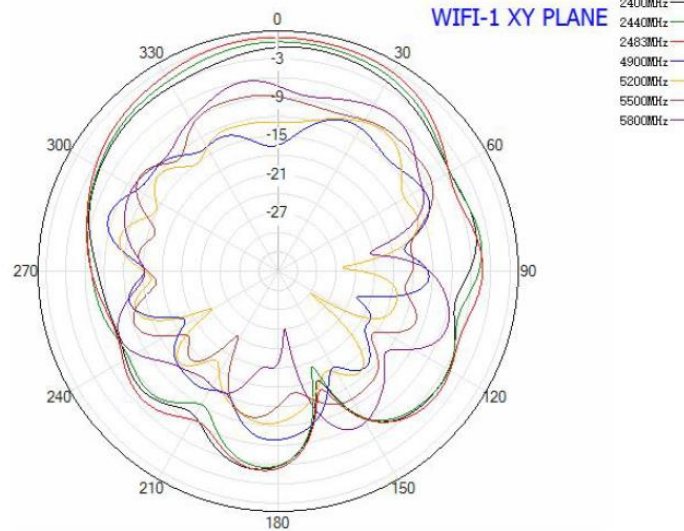

Maswell 7 in 1 5G 4x4 MIMO WiFi 2x2 MIMO and GNSS High-precision Combination Antenna

AN.4MIMO.700.5000.4C.2W.1GNSS

WiFi Antenna Part Pattern

